

Cuerpos geométricos

DESARROLLO DEL TETRAEDRO

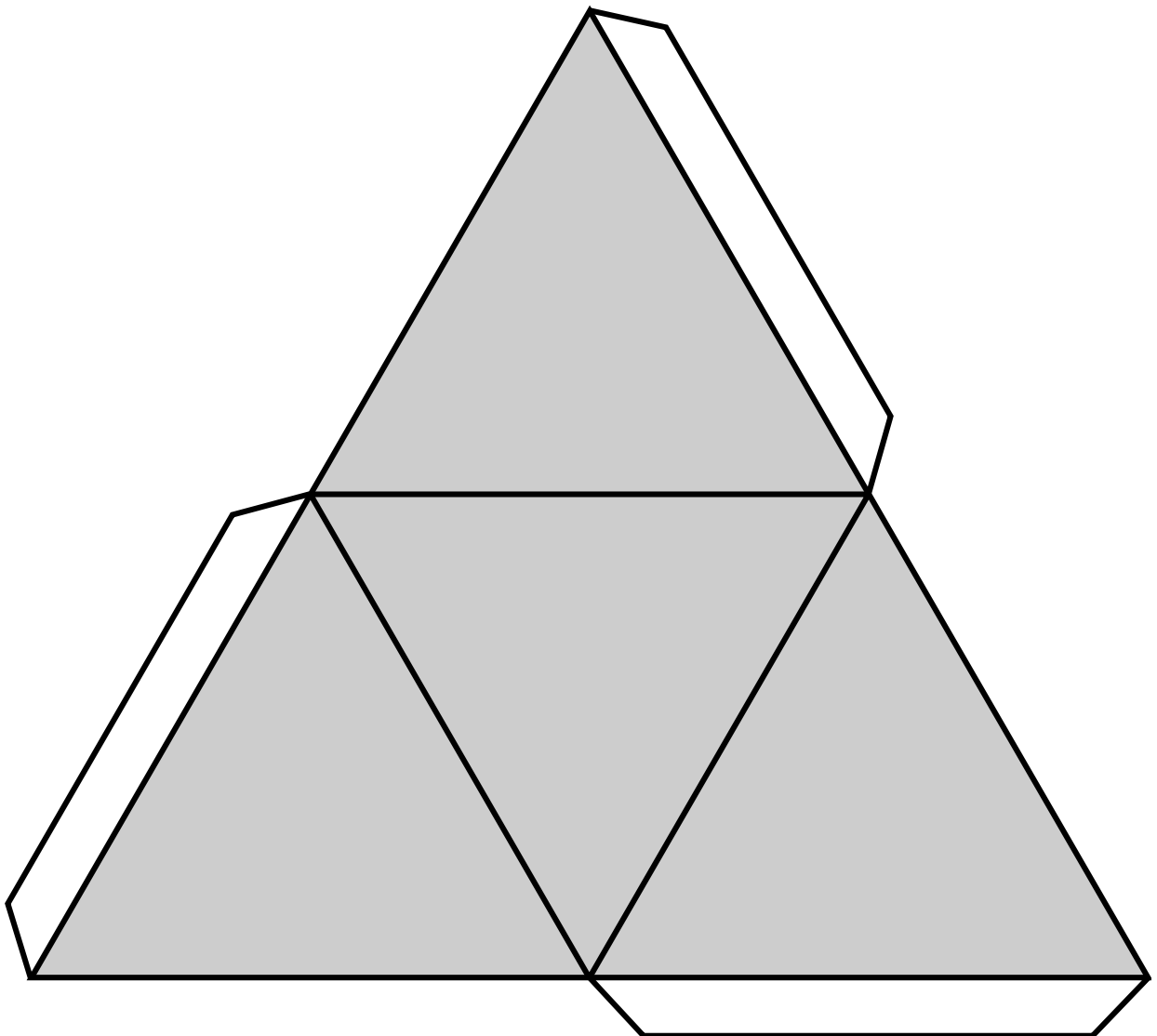
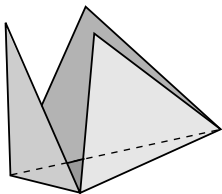
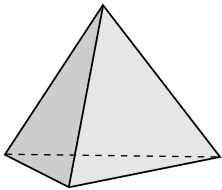

Cuerpos geométricos

DESARROLLO DEL CUBO O HEXAEDRO

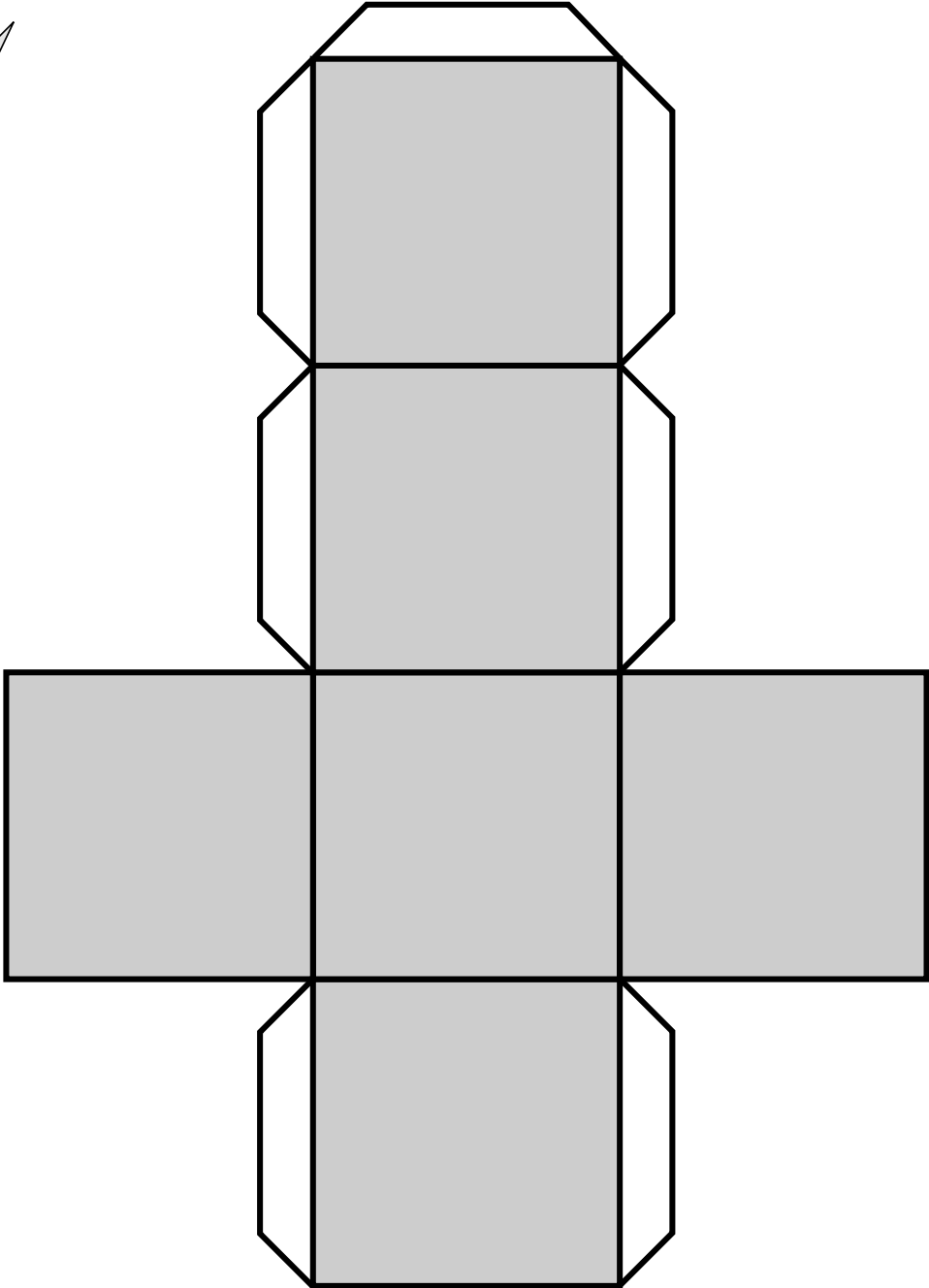
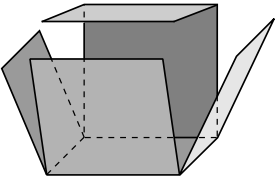
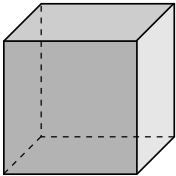

Cuerpos geométricos

DESARROLLO DEL OCTAEDRO

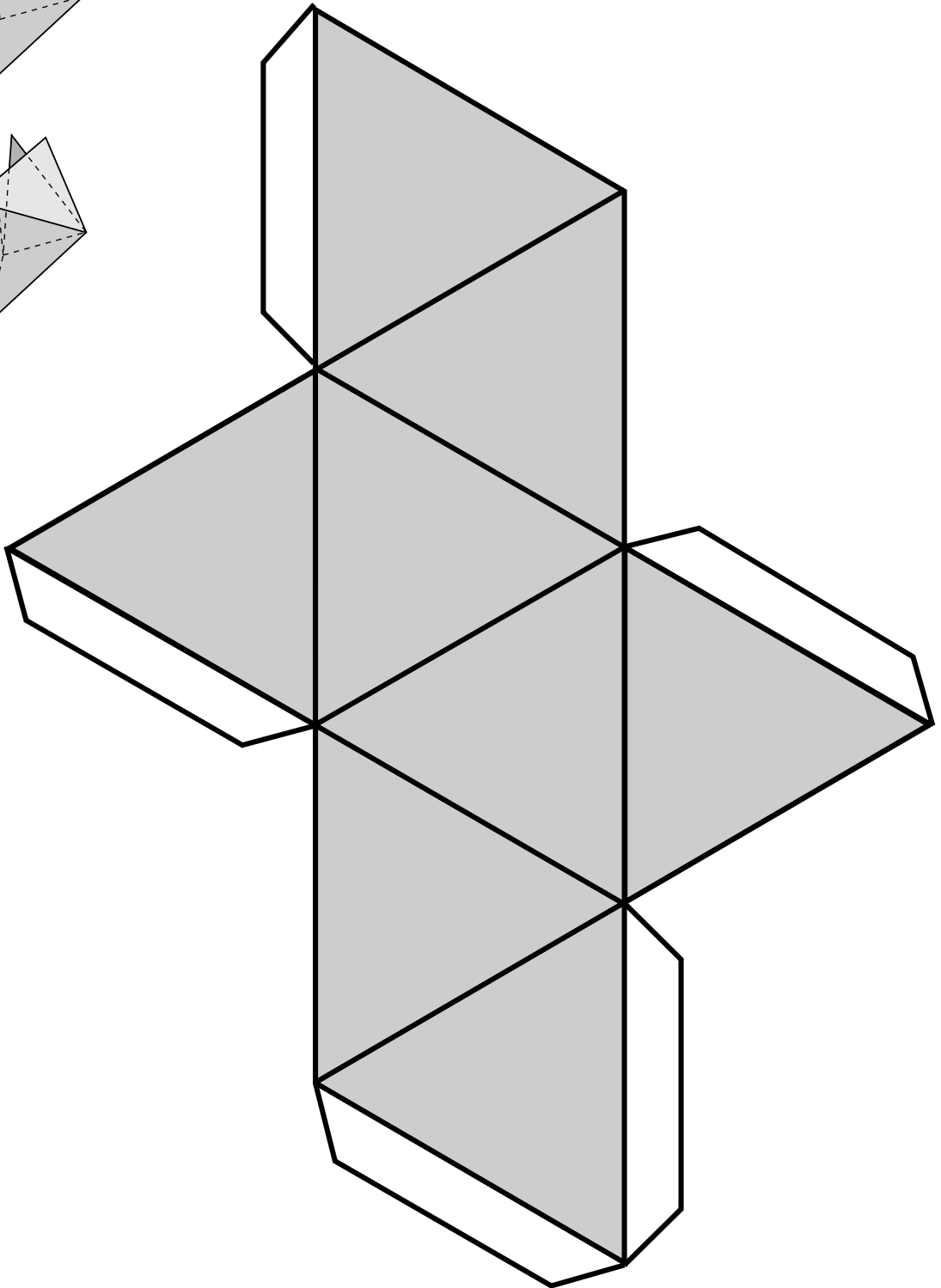
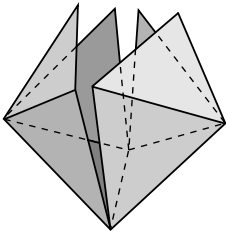
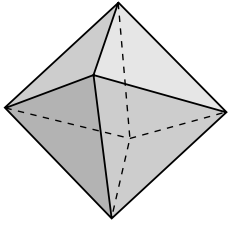

Cuerpos geométricos

DESARROLLO DEL DODECAEDRO

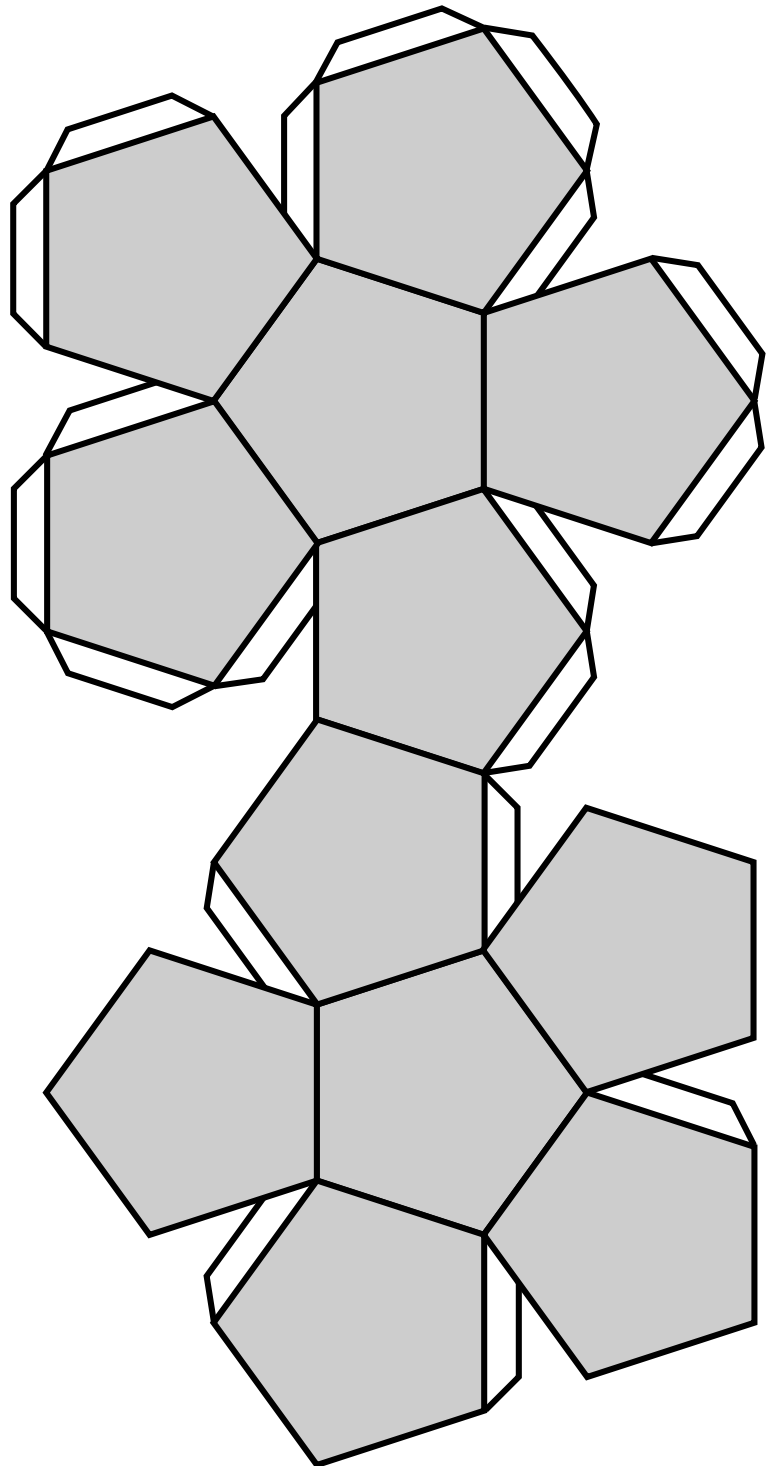
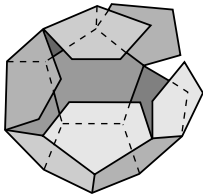
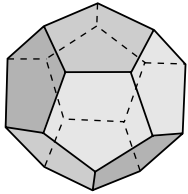

Cuerpos geométricos

DESARROLLO DEL ICOSAEDRO

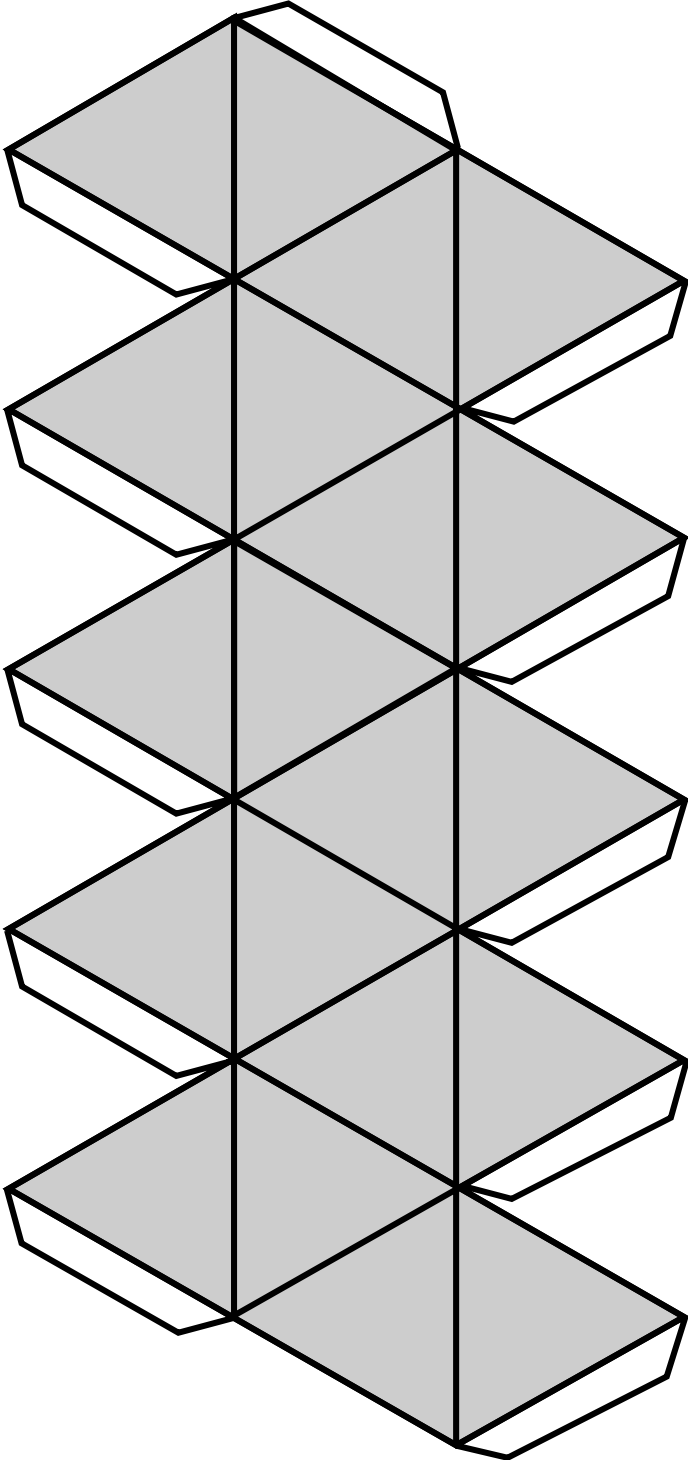
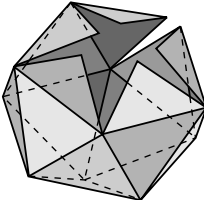
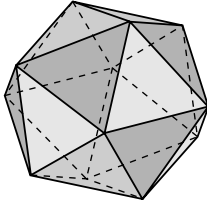

Cuerpos geométricos

DESARROLLO DEL ORTOEDRO O PRISMA CUADRANGULAR RECTO

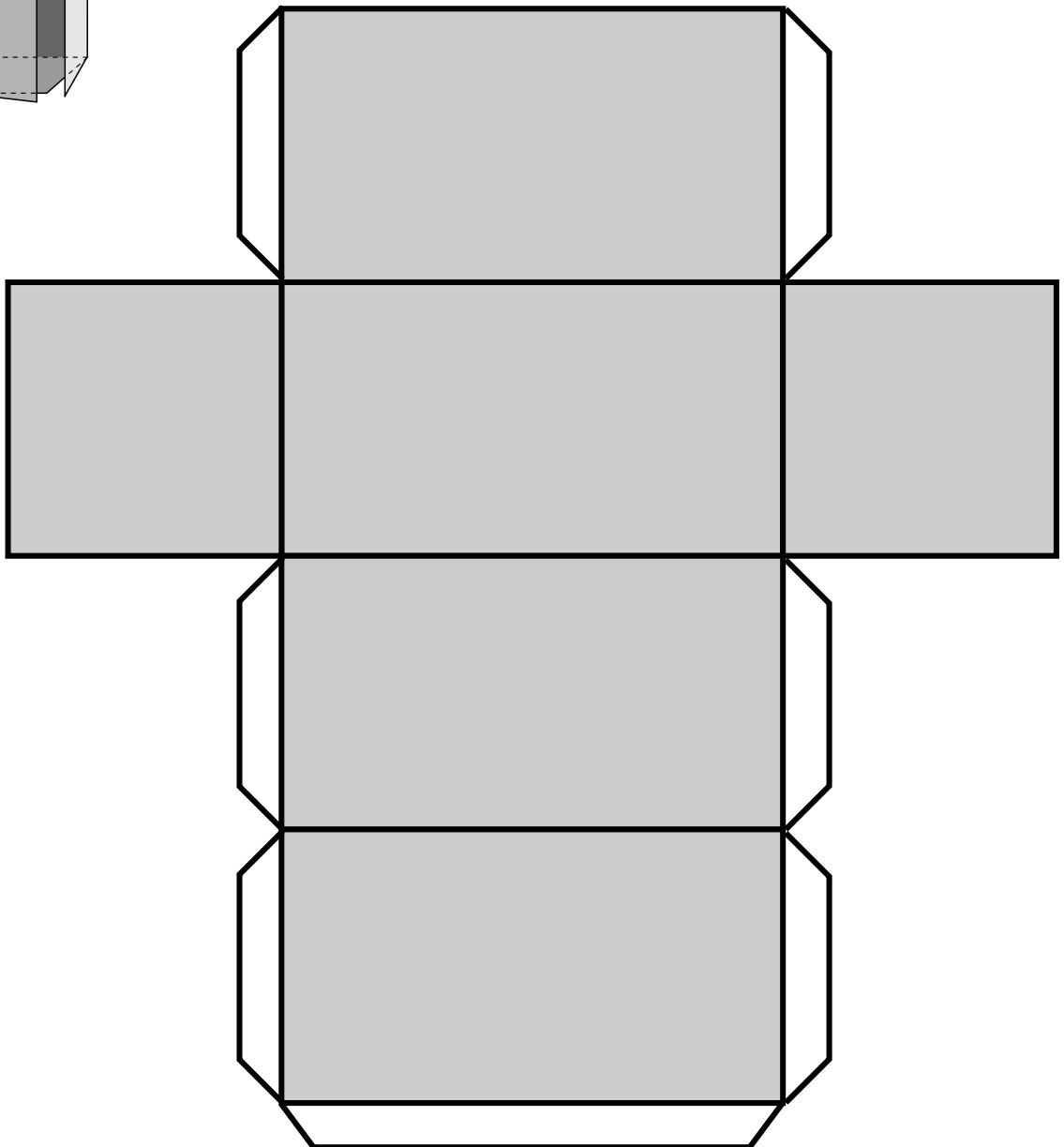
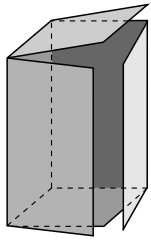
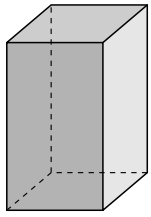

Cuerpos geométricos

DESARROLLO DEL PRISMA PENTAGONAL RECTO

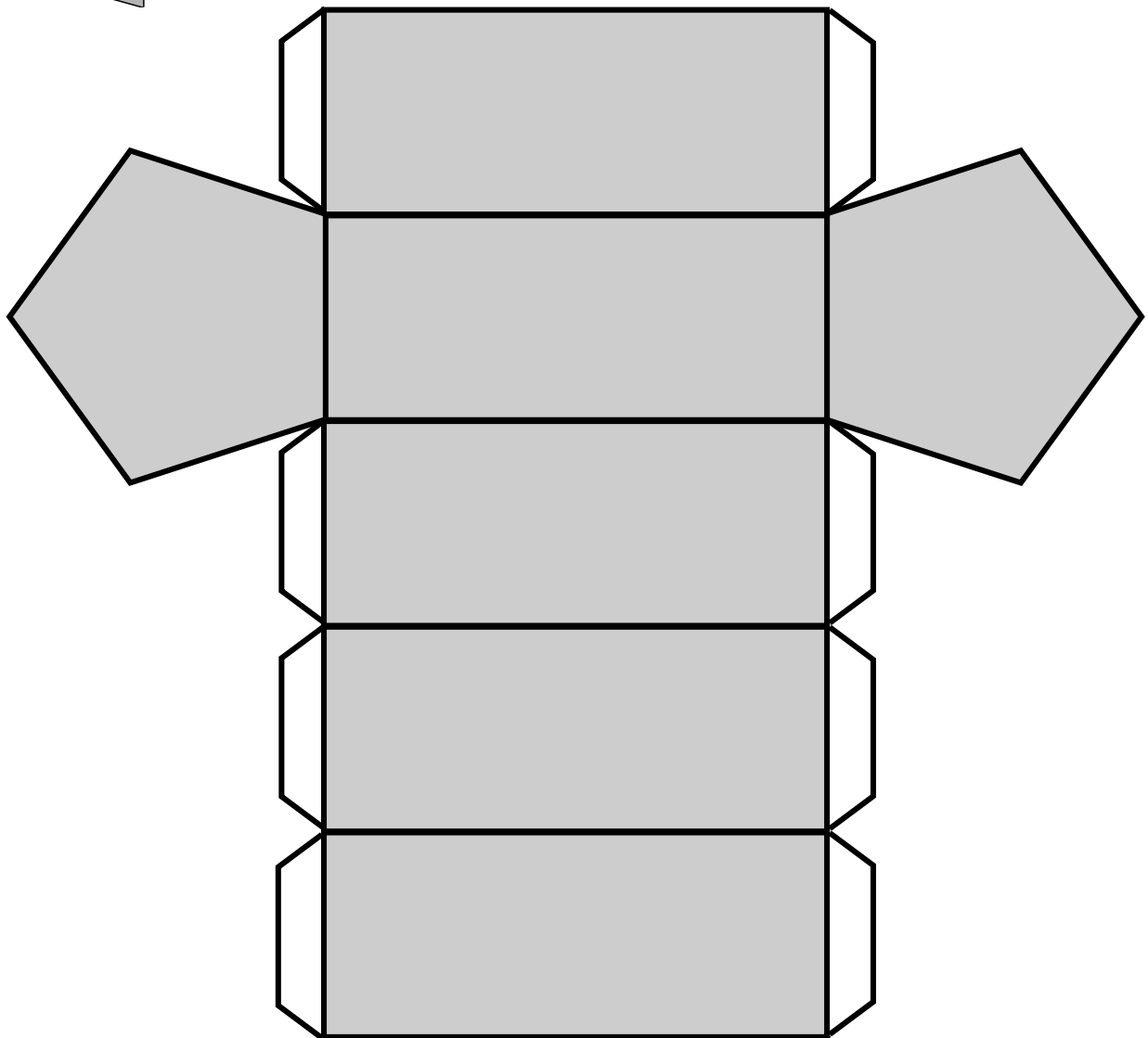
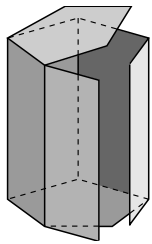
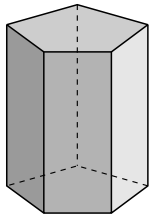

Cuerpos geométricos

DESARROLLO DEL PRISMA HEXAGONAL RECTO

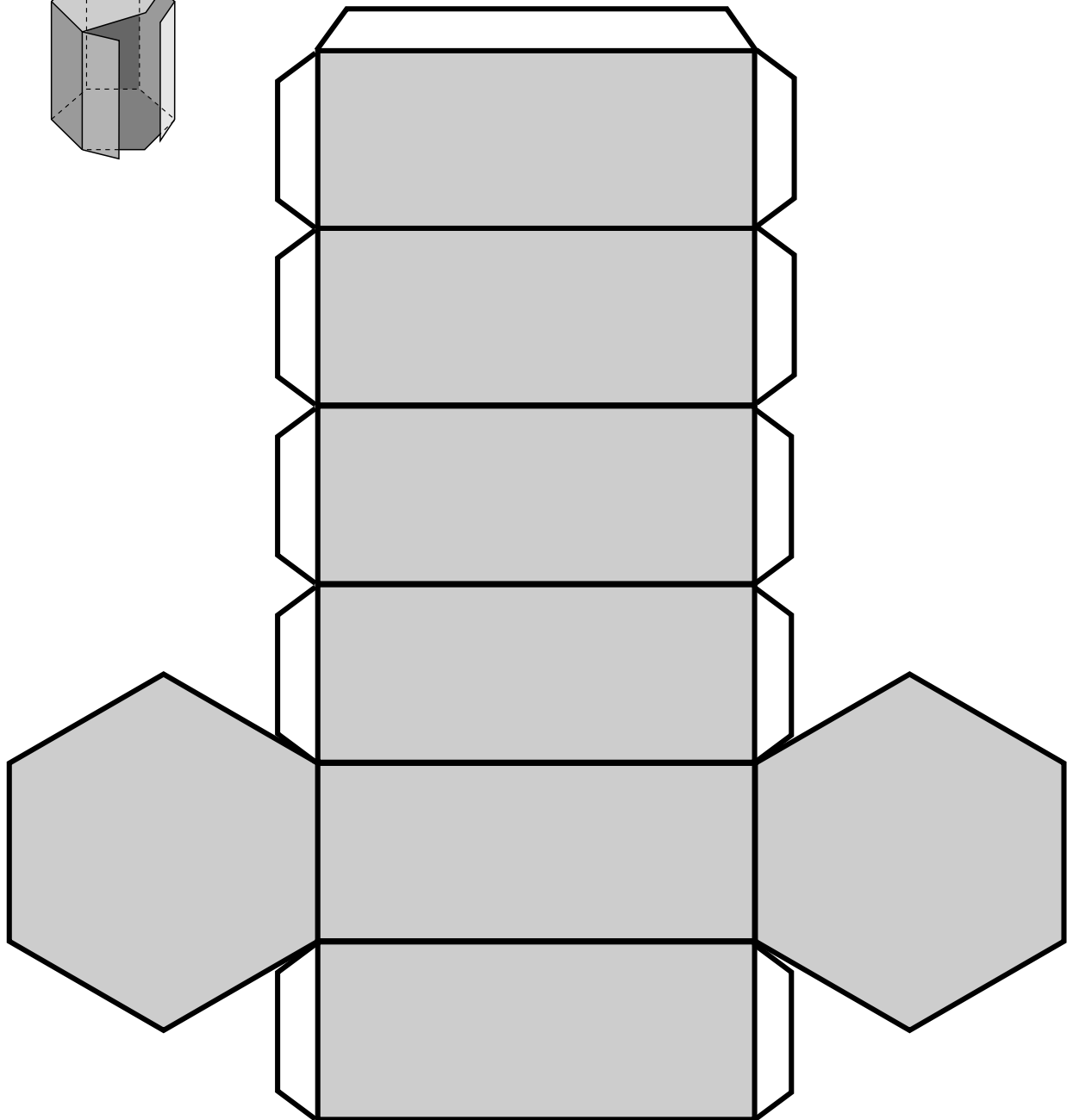
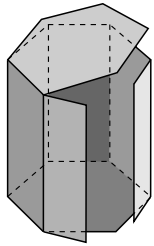
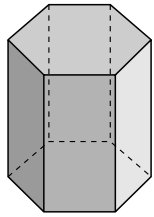

Cuerpos geométricos

DESARROLLO DE LA PIRÁMIDE CUADRANGULAR RECTA

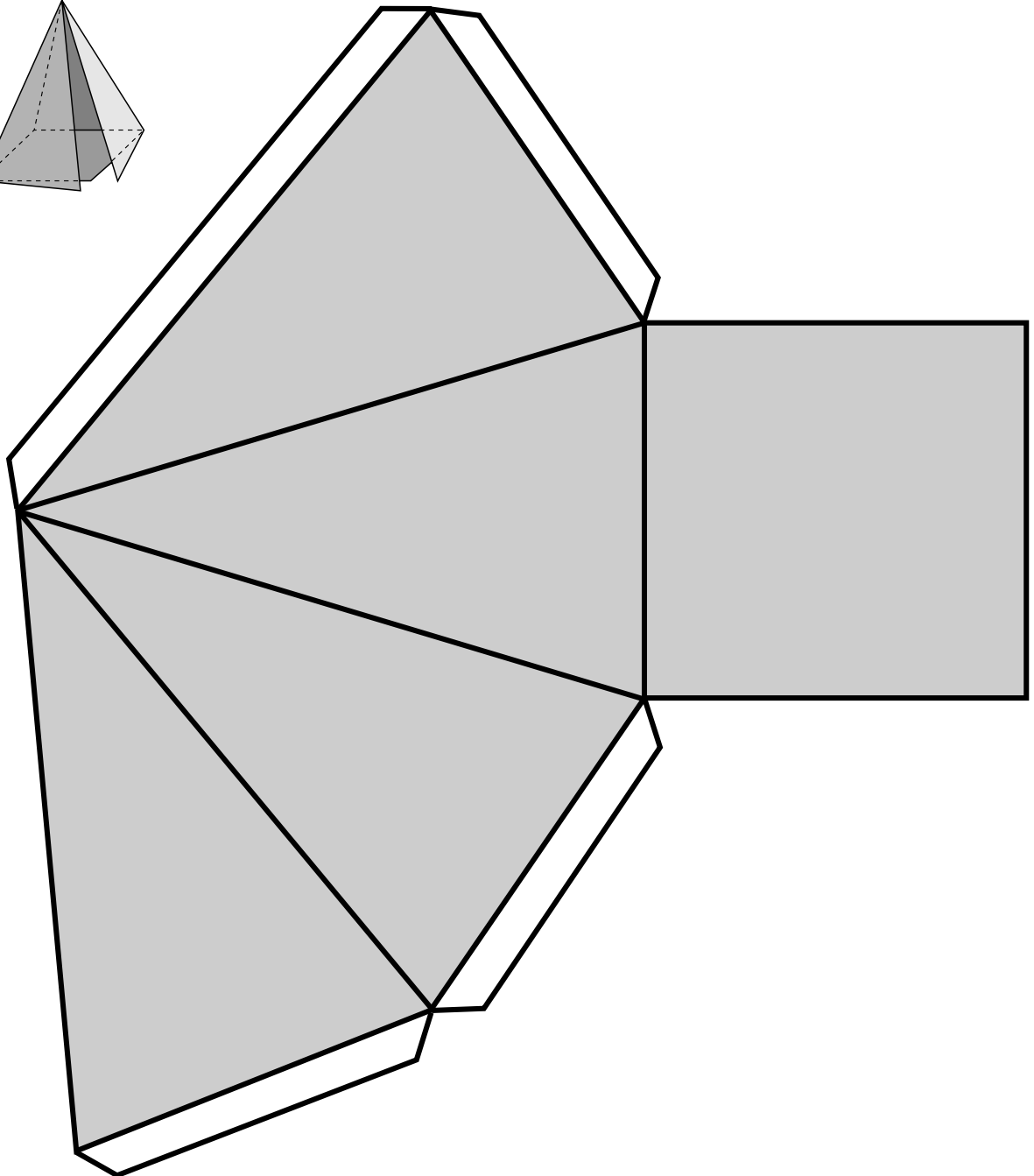
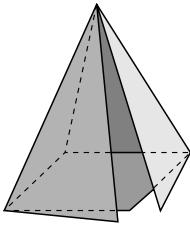
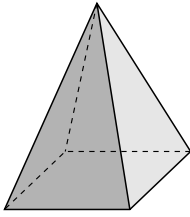

Cuerpos geométricos

DESARROLLO DE LA PIRÁMIDE PENTAGONAL RECTA

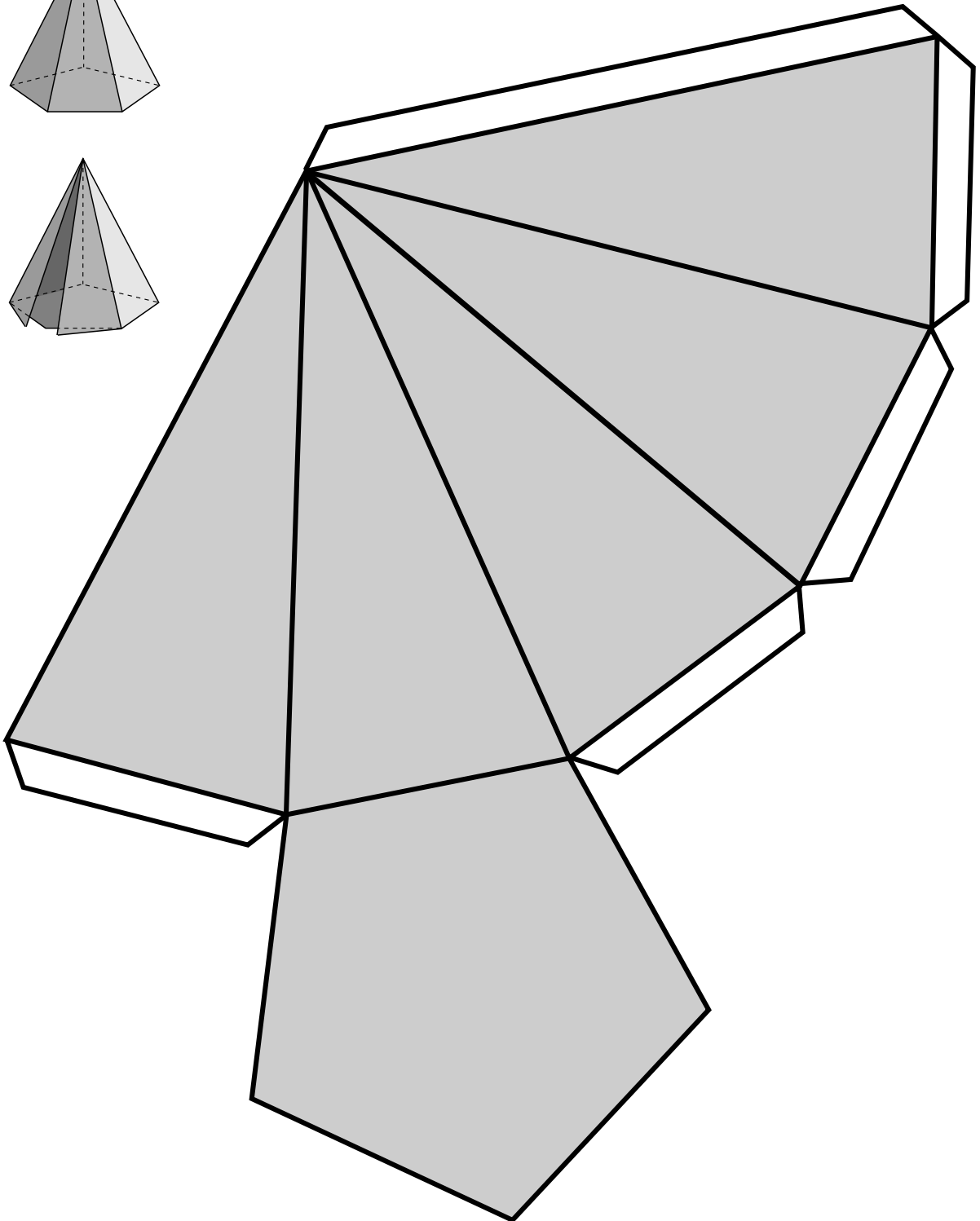
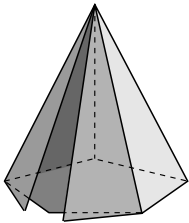
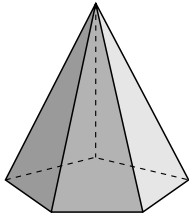

Cuerpos geométricos

DESARROLLO DE LA PIRÁMIDE HEXAGONAL RECTA

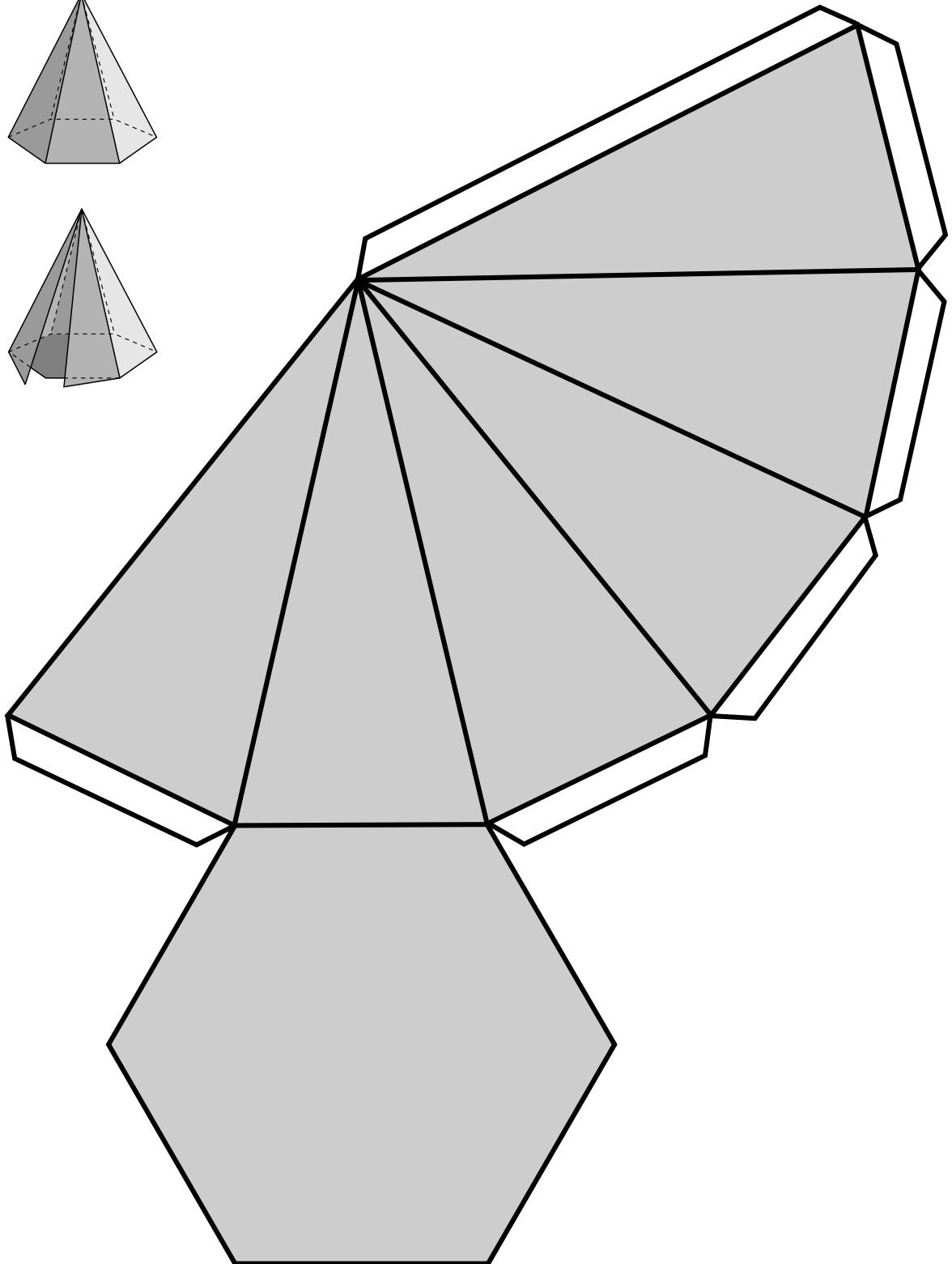
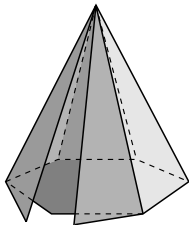
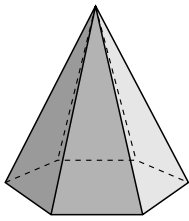

Cuerpos geométricos

DESARROLLO DEL TRONCO DE PIRÁMIDE CUADRANGULAR RECTO

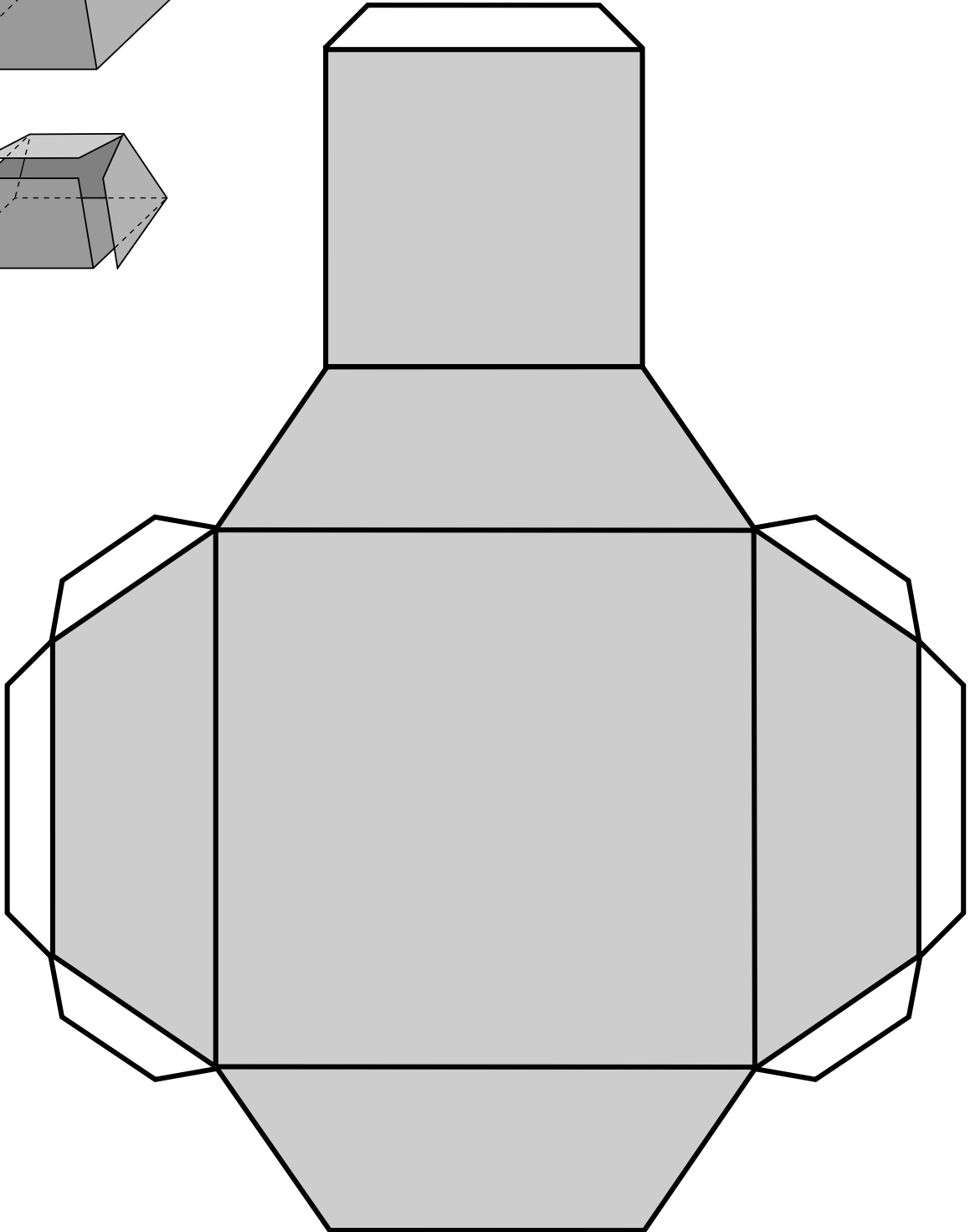
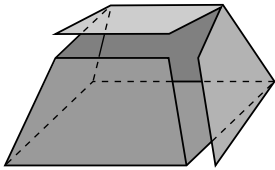
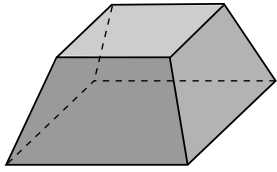

Cuerpos geométricos

DESARROLLO DEL TRONCO DE PIRÁMIDE PENTAGONAL RECTO

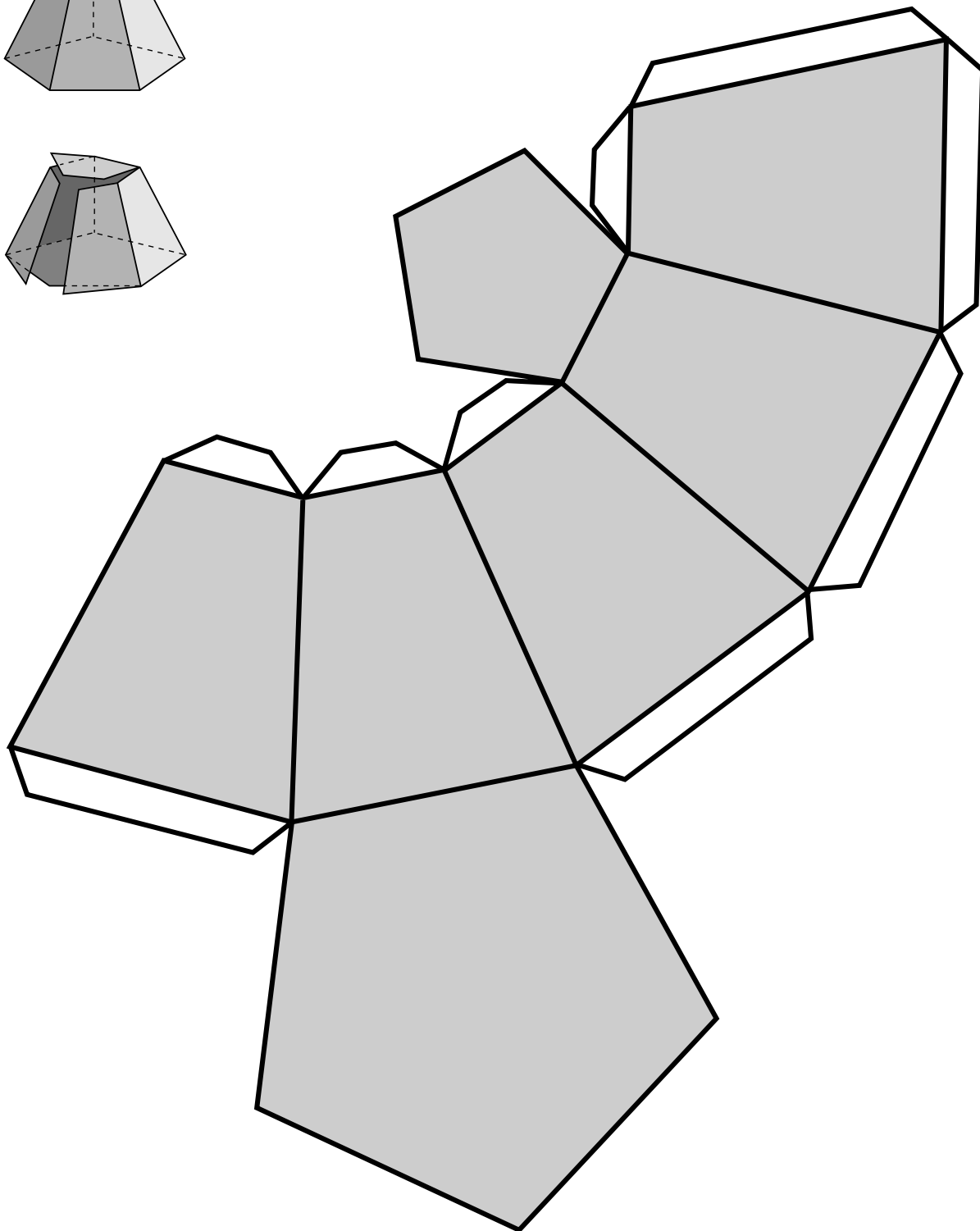
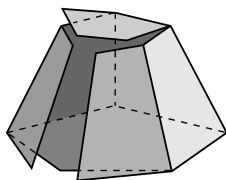
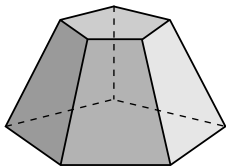

Cuerpos geométricos

DESARROLLO DEL CILINDRO

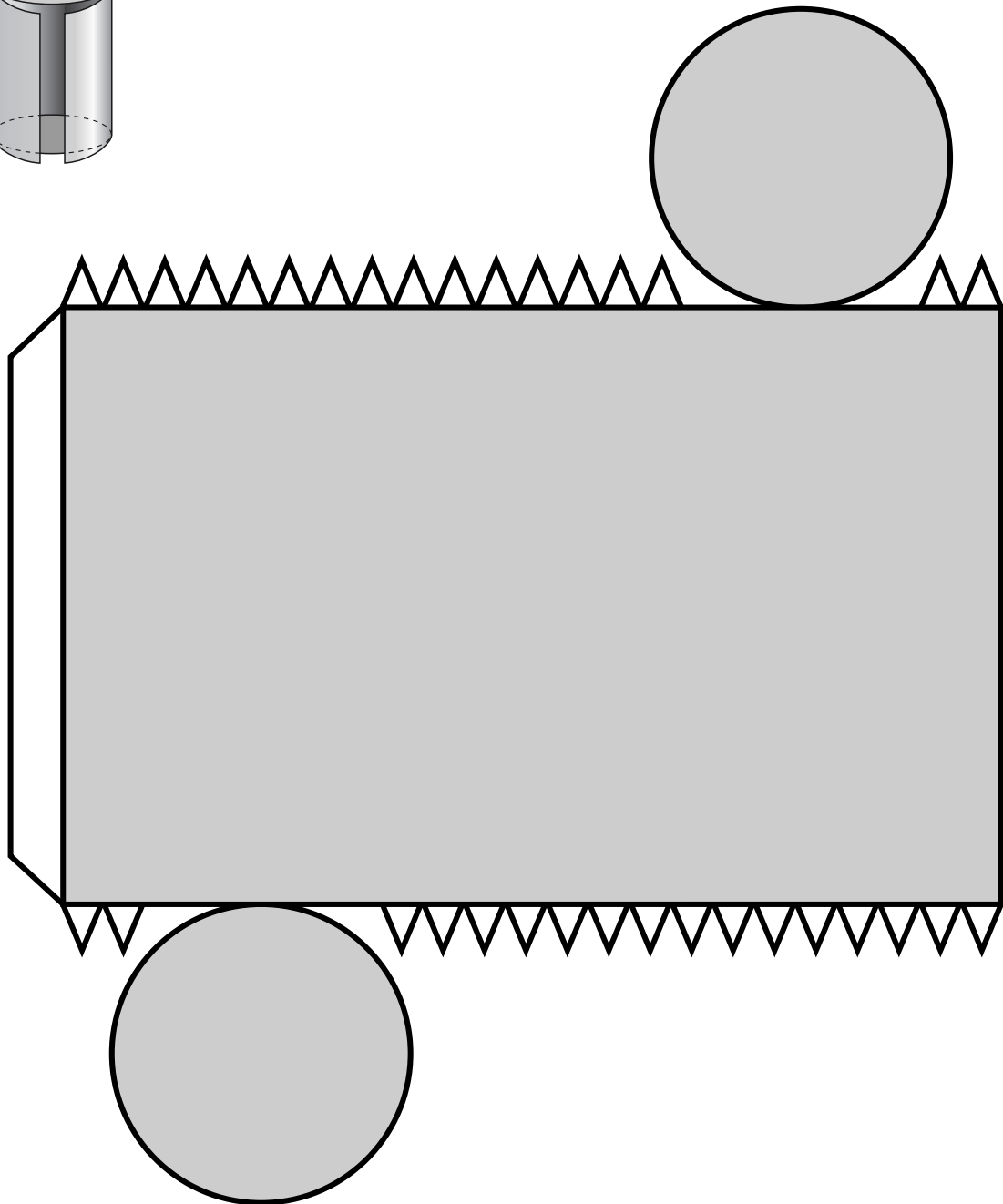
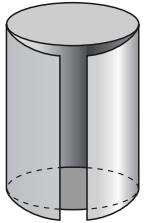
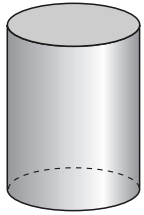

Cuerpos geométricos

DESARROLLO DEL CONO

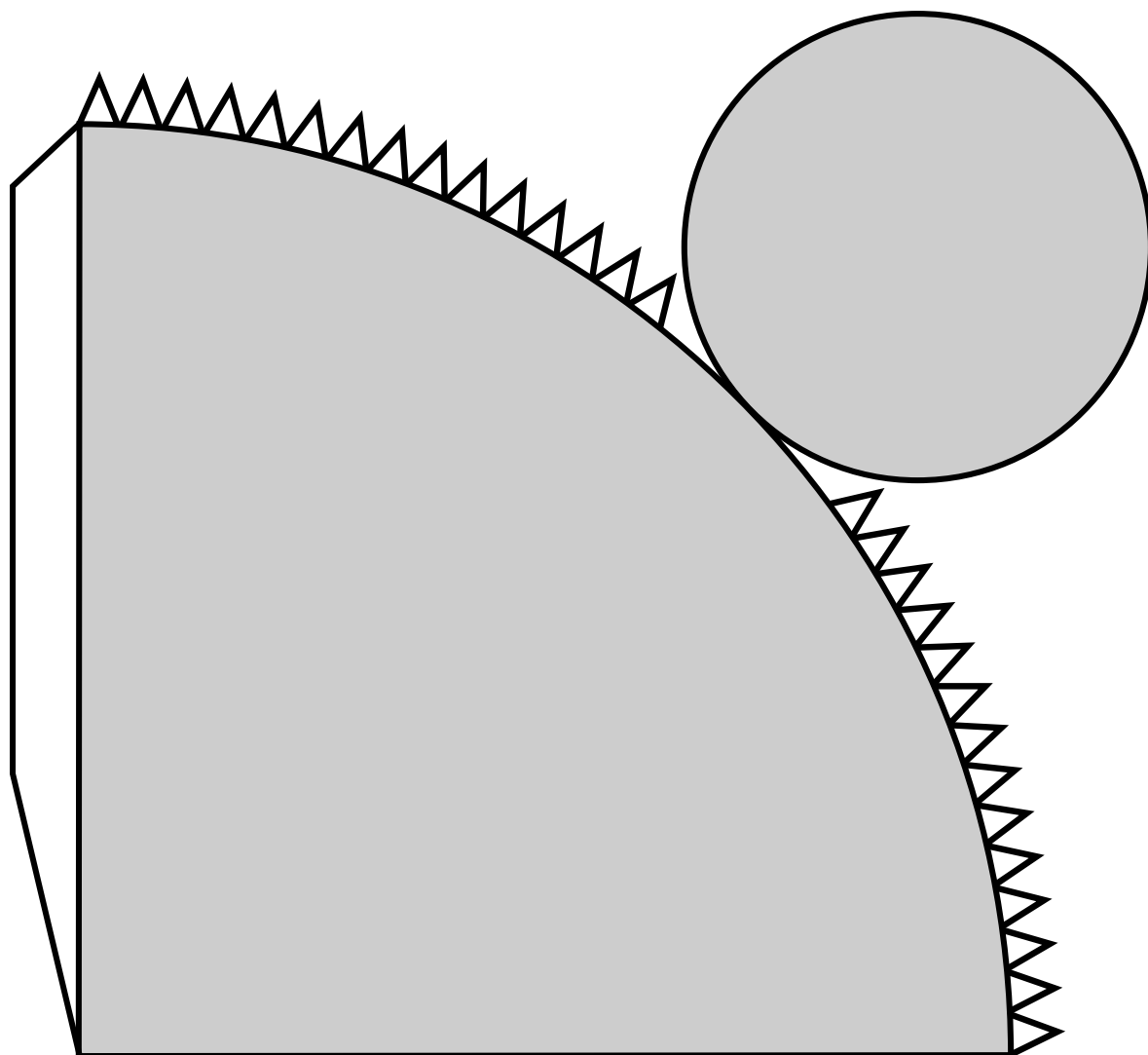
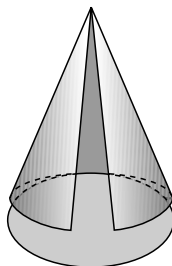
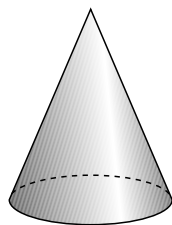

Cuerpos geométricos

DESARROLLO DEL TRONCO DE CONO

